

Article number: 20343632M840KRE

Description: E+G levelling foot
GN 343.6-32-M8-40-KRE

Measures

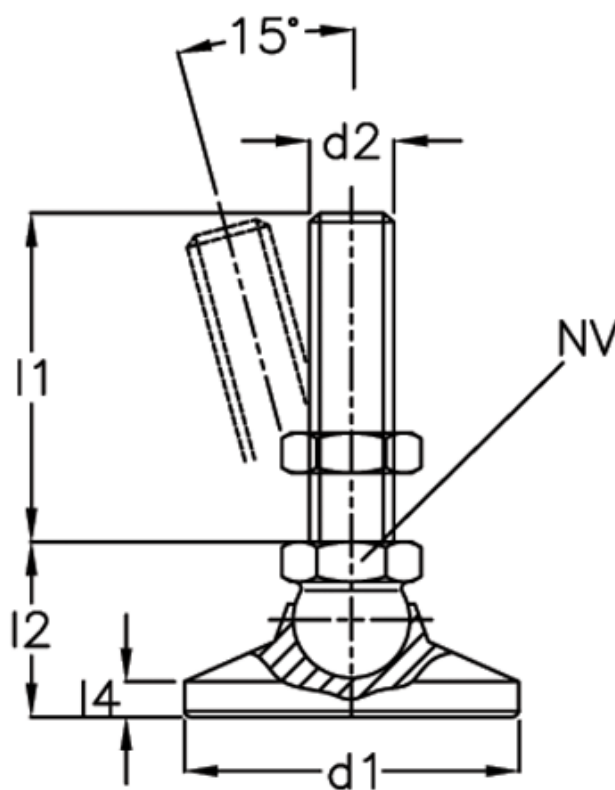

A/F	= 12
d1	= 32
d2	= 8
l1	= 40
l2	= -
l4	= -
Static load (N)	= 10
Weight in (g)	= 52